



fan data

27.01.2025

version FANselect V 1.01 (250124), AMCA V 1.03 September, 2021
RLT V 1.00 Dezember, 2021 / 1.25.01.24 | 30813 | (user ZAFS20813)



type	FN035-4EW.0F.A7P3
article no.	171264 Portfolio STD-WW

technical data

motor		AC
mains supply	-	1~ 230V 50Hz
nominal current (I_N)	A	0.65
capacitor (C_{400V})	μF	3.0
ambient temperature, max. limit (t_a)	$^{\circ}C$	70
efficiency grade η_{statA}	%	29,2
efficiency grade N_{actual} N_{target}		40,9 40
ErP-conformity		2015
grille influence		pressure side not measured

fan data

SFP-class SFP-value (P_{SFP})	- Ws/m^3	1 193
FEI	-	2.33
airflow volume (q_v)	m^3/h	2379
pressure, stat. (p_{sF}) tot. (p_F)	Pa	45 73
electrical power input (P_1)	W	128
efficiency grade, stat. (η_{sF}) tot. (η_F)	%	23.4 37.7
fan speed (n) max. (n_{max})	1/min	1410 1445
frequency (f_{DP}) (f_{max})	Hz	50 60
voltage (U_{DP})	V	208
current (I_{DP})	A	0.64
acoustics, suction side ($L_{w(A),5}$) ($L_{w,5}$)	dB	72 74
acoustics, pressure side ($L_{w(A),6}$) ($L_{w,6}$)	dB	72 75
dimensions (w x h x d)	mm	441 x 441 x 182
product weight (m_{pr})	kg	5.1

PF:PF_50; Type:FN035-4EW; STol:+-10 %

FANselect



performance curve / acoustics

27.01.2025

Version FANselect V 1.01 (250124), AMCA V 1.03 September, 2021
 RLT V 1.00 Dezember, 2021 / 1.25.01.24 | 30813 | (user ZAFS20813)

1

FN035-4EW.0F.A7P3

Measured in full nozzle without guard grille in air flow direction V in installation type A according to ISO5801

171264 | Portfolio STD-WW

measurement density 1.16 [kg/m³]

air performance p_{sF}

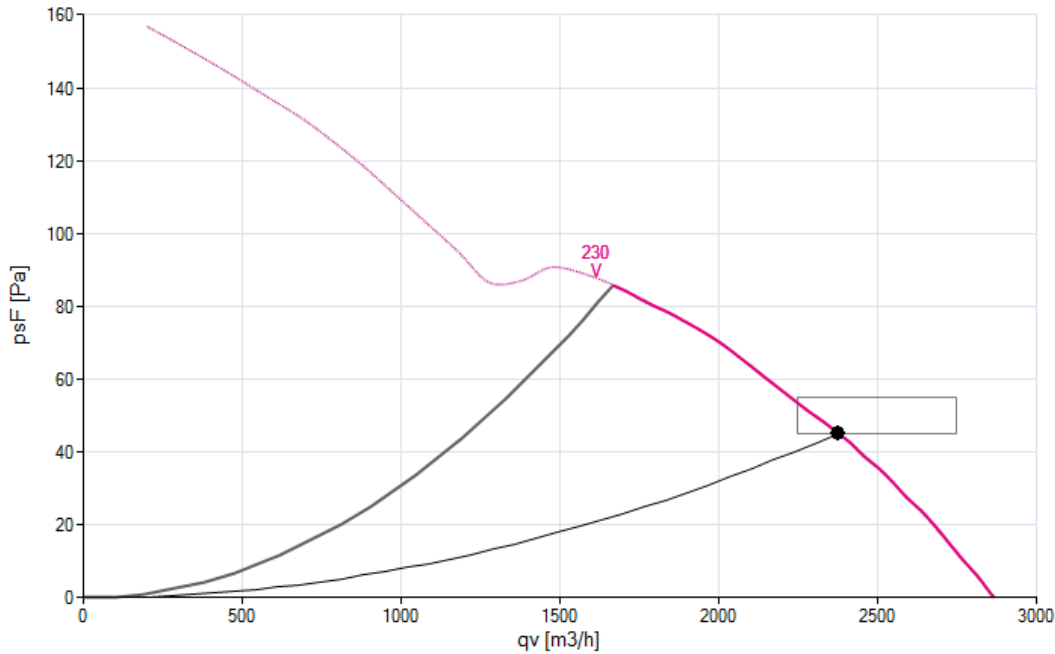

acoustics ($L_{w(A),5}$)

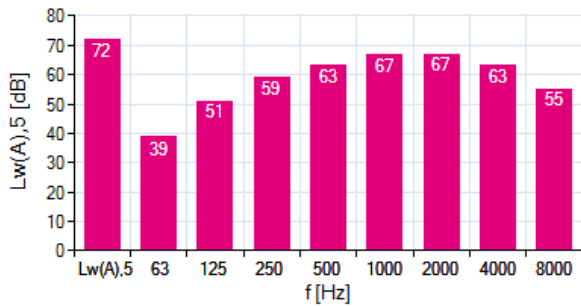

acoustics ($L_{w(A),6}$)

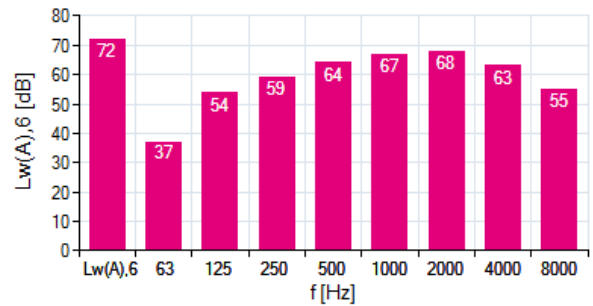

1 FN035-4EW.0F.A7P3

f [Hz]	sum	63	125	250	500	1000	2000	4000	8000
$L_{w(A),5}$	72	39	51	59	63	67	67	63	55
$L_{w,5}$	74	63	66	67	67	67	66	62	56

f [Hz]	sum	63	125	250	500	1000	2000	4000	8000
$L_{w(A),6}$	72	37	54	59	64	67	68	63	55
$L_{w,6}$	75	62	68	67	67	66	67	62	56

FANselect



efficiency grade / power input

27.01.2025

Version FANselect V 1.01 (250124), AMCA V 1.03 September, 2021
 RLT V 1.00 Dezember, 2021 / 1.25.01.24 | 30813 | (user ZAFS20813)

1

FN035-4EW.0F.A7P3

Measured in full nozzle without guard grille in air flow direction V in installation type A according to ISO5801

171264 | Portfolio STD-WW

measurement density 1.16 [kg/m³]

efficiency grade η_F

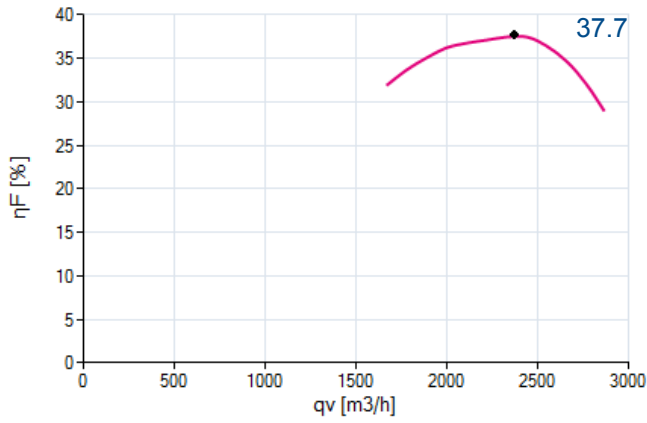

efficiency grade η_{sF}

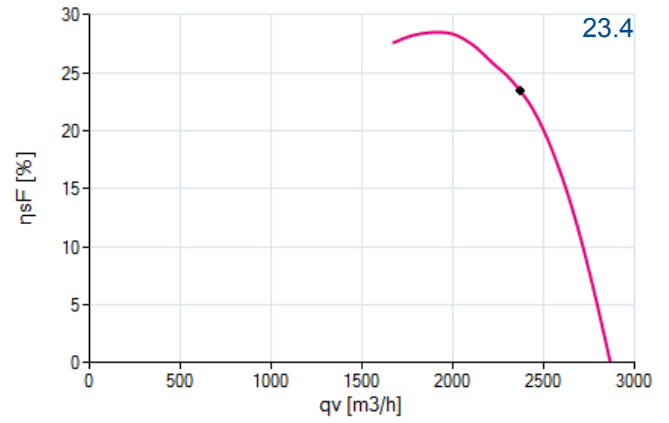

power input P_1

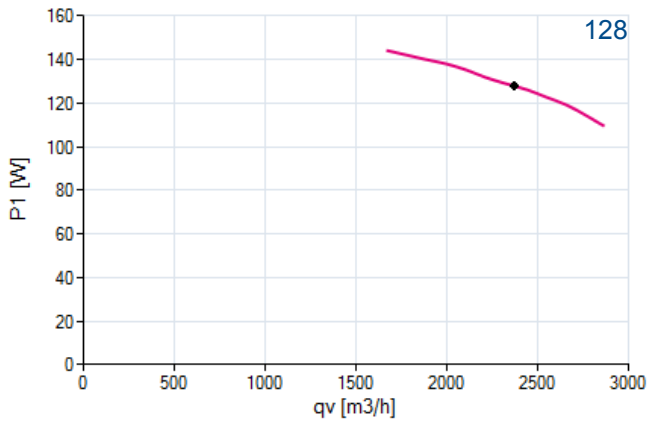



nominal values

version FANselect V 1.01 (250124), AMCA V 1.03 September, 2021
RLT V 1.00 Dezember, 2021 / 1.25.01.24 | 30813 | (user ZAFS20813)

27.01.2025

1



FN035-4EW.0F.A7P3

171264

1~ 230V +10/-10 50Hz P1 0.15kW P2 0.10kW
 0.65A DI=35% 1390/MIN 3.0µF/400V 70°C
 1~ 230V +10/-10 60Hz P1 0.23kW P2 0.13kW
 1.00A DI=15% 1520/MIN 3.0µF/400V 60°C
 IP54 THCL155

drawing

version FANselect V 1.01 (250124), AMCA V 1.03 September, 2021
RLT V 1.00 Dezember, 2021 / 1.25.01.24 | 30813 | (user ZAFS20813)

27.01.2025

1



FN035-4EW.0F.A7P3

171264

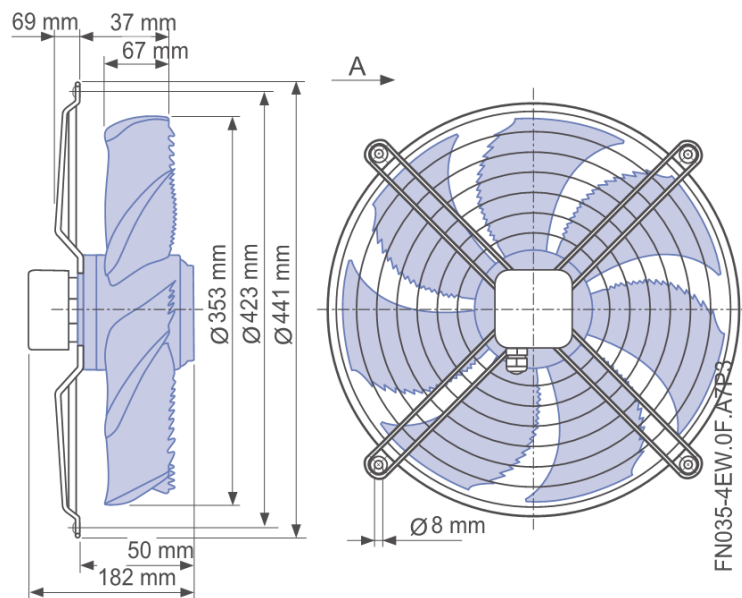

wiring diagram

version FANselect V 1.01 (250124), AMCA V 1.03 September, 2021
RLT V 1.00 Dezember, 2021 / 1.25.01.24 | 30813 | (user ZAFS20813)

27.01.2025

1



FN035-4EW.0F.A7P3

171264

1~Motor mit Kondensator und Thermostatschalter.
 1~Motor with capacitor and thermostatic switch.
 Moteur monophasé avec condensateur et interrupteur thermostatique.

U2	blau oder grau	blue or grey	bleu ou gris
Z2	schwarz	black	noir
TB	braun	brown	brun

not available



Anschlussschaltbild im Anschlusskasten aufbewahren.
 Keep wiring diagram in terminal box.
 Conserver le schéma de raccordement dans la boîte à bornes.

FANselect



system components

27.01.2025

Version FANselect V 1.01 (250124), AMCA V 1.03 September, 2021
RLT V 1.00 Dezember, 2021 / 1.25.01.24 | 30813 | (user ZAFS20813)



type	FN035-4EW.0F.A7P3
article no.	171264